

Fatigue Crack Growth Simulation using S-version FEM

M. Kikuchi¹, Y. Wada², A. Utsunomiya³ and Y. Li⁴

Summary

Fatigue crack growth under mixed mode loading conditions is simulated using S-FEM. By using S-FEM technique, only local mesh should be re-meshed and it becomes easy to simulate crack growth. By combining with auto-meshing technique, local mesh is re-meshed automatically, and curved crack path is modeled easily. Three dimensional surface crack problem is solved by this technique. Pure mode I crack and slant crack problems are solved, and fatigue crack growth processes are simulated. The change of aspect ratio of surface crack and distributions of stress intensity factor along crack front are evaluated and discussed.

Introduction

Evaluation of fatigue life of mechanical component is one of the most important problems for the integrity of mechanical system. Fatigue crack initiates at stress concentrated zone, and grows gradually. By the growth of the crack, stress intensity factor increases and finally it reaches to some critical value. Before it reaches to this critical value, mechanical engineers should find this crack and manage to avoid a final fracture accident. If there are plural fatigue cracks, they grow by interacting each other. In this case, crack tip stress field becomes complicated, and stress state at the crack tip becomes mixed mode loading condition. Usually finite element method (FEM) is used to simulate the crack growth behavior. But under mixed mode loading condition, crack shape changes with the crack growth, and re-modeling of the crack configuration is needed. This is really tough and time consuming work. Many numerical techniques have been developed to solve this problem. They are ; Element Free Galerkin method[1], Free Mesh method[2], X-FEM[3] and S-version FEM[4]. Authors have developed S-FEM code to solve crack problem[5] and solved plural crack problem using S-FEM and simulated fatigue crack growth considering interactions between two cracks[6].

In this paper, S-version FEM (S-FEM) is employed to solve three-dimensional problem. In S-FEM, crack area is modeled by local mesh. Re-modeling of new crack configuration is done only in local mesh. Whole structure is modeled by global mesh, and it is not necessary to re-model it. By combining auto-mesh technique, local mesh is re-meshed automatically.

At first, surface crack under pure mode I loading condition is simulated. Then, slant surface crack problem is solved, and fatigue crack growth is simulated. The

¹Tokyo University of Science, Japan

²Suwa Tokyo University of Science, Japan

³Graduation school of Tokyo University of Science, Japan

⁴Northwestern Polytechnical University, People's Republic of China

changes of K_{II} and K_{III} at crack front and change of aspect ratio of surface crack due to crack growth are evaluated and discussed.

S-FEM for multi-local problem

By using S-FEM, plural cracks problem is solved easily. In Fig.1, there are two cracks in a solid and tension load is subjected. For this problem, two local meshes are used to model this problem, and whole domain is modeled as a global mesh, as shown in Fig.2. Finite element formulation for this problem is described by eq.(1).

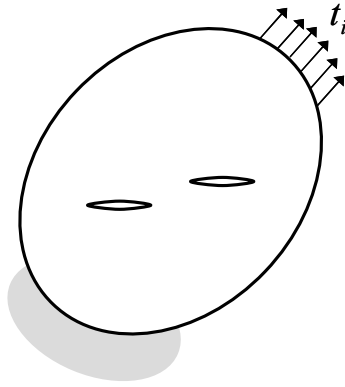

Figure 1: Two cracks in a plate in tension.

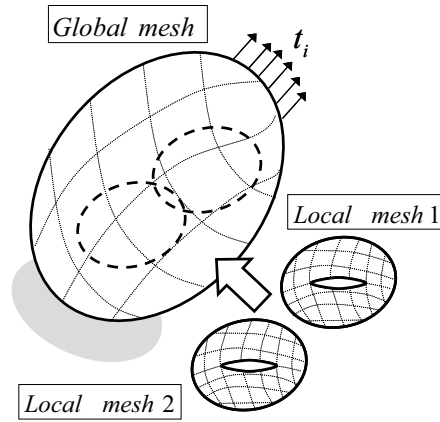

Figure 2: mesh and global mesh.

$$\begin{bmatrix} K^{GG} & K^{GL1} & K^{GL2} \\ & K^{L1L1} & K^{L1L2} \\ \text{sym.} & & K^{L2L2} \end{bmatrix} \begin{Bmatrix} u^G \\ u^{L1} \\ u^{L2} \end{Bmatrix} = \begin{Bmatrix} f^G \\ f^{L1} \\ f^{L2} \end{Bmatrix} \quad (1)$$

Where U^G , U^{L1} , U^{L2} , f^G , f^{L1} , f^{L2} are displacement and nodal equivalent forces of global mesh, local-1 mesh and local-2 mesh, respectively. K^{GG} , K^{L1L1} and K^{L2L2} are stiffness matrixes of each mesh. K^{GL1} and K^{L1L2} express relations between global and local-1 mesh, and local-1 and local-2 mesh, respectively. They are expressed by following equations.

$$K^{GL1} = \int_{\Omega^{L1}} [B^G]^T [D] [B^{L1}] d\Omega^{L1} \quad (2)$$

$$K^{L1L2} = \int_{\Omega^{L2}} [B^{L1}]^T [D] [B^{L2}] d\Omega^{L2} \quad (3)$$

Crack growth criteria

In mixed mode loading condition, K_I , K_{II} and K_{III} should be evaluated at the crack tip, and fatigue crack growth criteria are used as follows:

1. Crack growth direction: In three-dimensional stress field, K_I , K_{II} and K_{III} affect crack growth direction. Several theories have been proposed to predict crack growth direction in such complicated stress field. In this study, σ'_I criterion, proposed by Richard et al.[7] is used, which determines crack growth direction by the following equation.

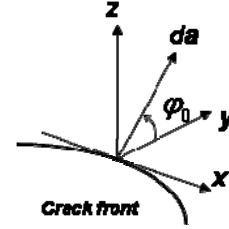

Figure 3: Crack growth direction.

$$\varphi_0 = \mp \left[A \frac{|K_{II}|}{K_I + |K_{II}| + |K_{III}|} + B \left(\frac{|K_{II}|}{K_I + |K_{II}| + |K_{III}|} \right)^2 \right] \quad (4)$$

where $\varphi_0 < 0^\circ$ for $K_{II} > 0$ and $\varphi_0 > 0^\circ$ for $K_{II} < 0$ and $K_I \geq 0$ with $A=140^\circ$, $B=-70^\circ$.

2. Crack growth rate: Equivalent stress intensity factor, K_{eq} , is defined by the next equation, and Paris' law [8] is used to calculate crack growth rate.

$$K_{eq} = \frac{K_I}{2} + \frac{1}{2} \sqrt{K_I^2 + 4(\alpha_1 K_{II})^2 + 4(\alpha_2 K_{III})^2} \quad (5)$$

where $\alpha_1 = K_{Ic}/K_{IIc}$ and $\alpha_2 = K_{Ic}/K_{IIIc}$ with $\alpha_1=1.155$, and $\alpha_2=1.0$.

$$da/dN = C (\Delta K_{eq})^n \quad (6)$$

Material is assumed to be Aluminum alloy T2017-T3, and $C=1.314 \times 10^{-10}$, $n=2.37$ are used as material constants.

Auto-mesh generation of curved surface crack

For the simulation of surface crack by fatigue loading, auto-mesh generation system is constructed. As shown in Fig.4, crack growth direction φ_0 and crack growth amount for some number of cycles are determined by equations (4) and (6) for several points along crack front. They are interpolated by spline curve, and new crack front is generated by Ferguson curve. New local mesh of this new surface crack is generated automatically. In each step, crack front history is stored in the database, and they are referred in generating new local mesh data.

Fig.5 shows one example of auto-mesh generation. The shape of surface crack is flat in the initial step, but finally it grows with curvature by mixed mode loading condition, and local mesh with curvature is generated, as shown in this figure.

It is difficult to generate three-dimensional mesh data using hexahedral element for arbitrary problem. But in this study, auto-mesh is generated only for local area including one surface crack. As the target of auto-mesh system is limited, it became possible to generate local mesh using hexahedral element.

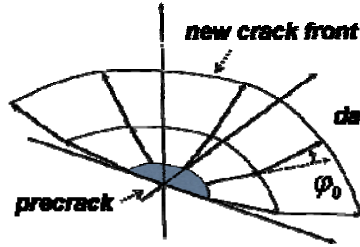

Figure 4: Generation of new crack front.

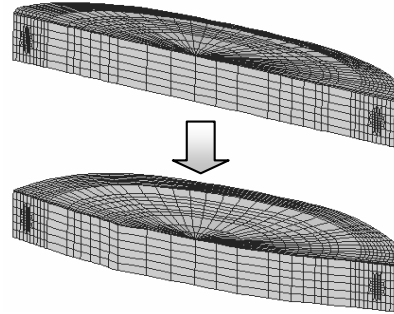

Figure 5: Mesh generation example.

Crack growth simulation of pure mode I crack

Fig.6 shows a surface crack problem in cyclic tension loading. Loading condition is symmetry with respect to crack surface, and fatigue crack growth occurs under pure mode I condition. The crack size at surface is $2c$ and depth is a , and aspect ratio of the crack, a/c , is changed from 0.1 to 1.0 in 6 cases. The initial crack size, $2c_0$ is 7.0mm.

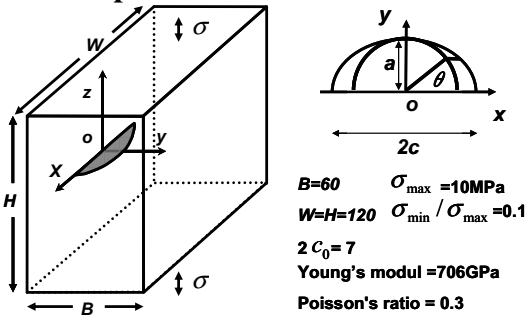

Figure 6: Crack growth direction.

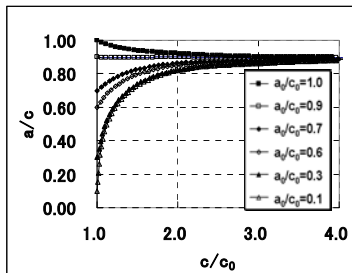

Figure 7: Changes of aspect ratio.

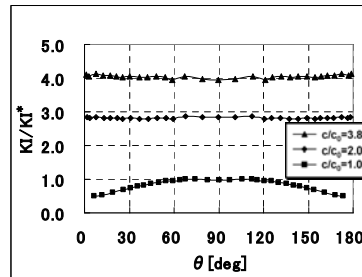

Figure 8: Changes of stress intensity factor.

Fig.7 shows changes of aspect ratios of 6 cases. The abscissa is normalized crack size at surface. It is interesting to note that all aspect ratios become to 0.9 due to fatigue crack growth. The changes of stress intensity factors along crack front are shown in Fig.8. This is a result of $a/c=0.1$ case. The abscissa of this figure shows the angle on crack front which is defined in Fig.6, and ordinate is stress intensity factor normalized by initial value at the crack bottom. At first, stress intensity factor is the largest at the bottom of the crack, and crack growth occurs mainly to

this direction. Due to crack growth, stress intensity factor becomes nearly constant along the crack front when c value becomes twice of the initial value. After then, surface crack grows keeping stress intensity factor constant, and finally aspect ratio saturates to 0.9.

Crack growth simulation of slant surface crack

Fig.9 shows a slant surface crack. The slant angle is 30 degree with respect to y axis. As this is a mixed mode problem, crack growth direction is predicted by equation (4), and new crack shape is modeled. By repeating crack growth simulation, crack surface grows by changing the growing surface as shown in this figure. Due to crack growth, crack surface becomes flat and normal to applied force. It seems that crack grows under mode I loading condition.

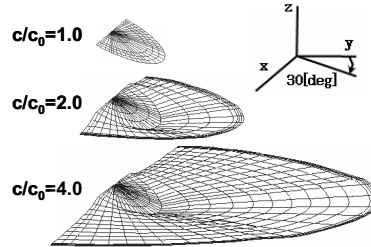
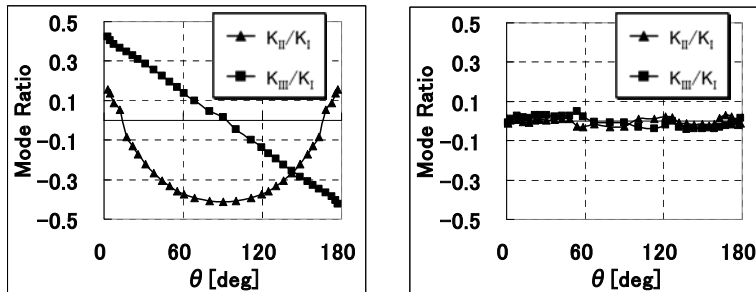

Figure 9: Growth of slant surface crack.



(a) Initial step ($c/c_0=1.0$).

(b) Final step ($c/c_0=4.0$)

Figure 10: Changes of stress intensity factors of slant surface crack.

Distributions of K_{II} and K_{III} along the crack front are shown in Fig.10 (a) and (b). At the initial step, K_{II} and K_{III} values are nearly half of K_I and changes largely along the crack front, as shown in Fig.10(a). Finally, these values become very small with respect to K_I value, and become nearly zero along the crack front. It means that fatigue crack growth occurs under pure mode I condition, which agrees with many experimental works for two-dimensional slant crack simulation [6].

Concluding remarks

It has been shown that S-FEM is useful for fatigue crack growth simulation. Several three-dimensional surface crack problems were solved well. Evaluation of interaction effect of plural surface crack is our next target.

References

1. Belytschko,T., et al., Int.J. Numer. Methods. Eng., 30 (1994), 229-256.

2. Yagawa, G., Yamada, T., *Comput. Mech*, 18 (1996), 383-386.
3. Belytschko, T., Black, T., *Int. J. Numer. Methods Eng.*, 45 (1999), 601-620.
4. Fish, J. et al., *Appl. Numer. Mathematics*, 14 (1994), 135-164.
5. Okada, H., Endoh, S. and Kikuchi. M., *Eng. Fra. Mesh.*, 72 (2005), 773-789.
6. Kikuchi, M. et al., *Proc. 7th FEOFS* (2007).
7. Richard, H. A., Fulland, M., Sander, S. N. (2005): Blackwell Publishing Ltd. *Fatigue Fract Engng Mater Struct*, 28, pp. 3-12.
8. Paris P.C., Erdogan, F., *J. bas. Engng. m Trans. ASME, Ser.D*, 85, (1963), 528-533.